



## F040 SERIES

In line medium pressure filters

Inline filters for operating pressure up to 70 bar, flow rate up to 400 l/min.  
Available with or without bypass, indicator port is a standard option to fit a visual or electrical differential indicator.



<b>HOUSING</b>	tested according to NFPA T3.10.5.1, ISO 10771, ISO 3968
<b>PRESSURE:</b>	Max operating: F040 DMD0005-8-11: 70 bar F040 DMD0015-30-45: 40 bar Burst: F040 DMD0005-8-11: 210 bar F040 DMD0015-30-45: 120 bar
<b>CONNECTIONS:</b>	G 3/4" ÷ 1 1/4"
<b>MATERIALS:</b>	Head: aluminium alloy Bowl: aluminium alloy Seal: NBR (FKM on request)
<b>BYPASS VALVE:</b>	No by-pass or 3,5 bar setting

<b>ELEMENT</b>	tested according to ISO 11170, 2941, 2942, 2943, 3724, 3968, 16889, 16908, 23181
<b>FILTER MEDIA:</b>	<b>For 30 bar differential collapse pressure:</b> Inorganic microfiber: E01B - E03B - E05B - E10B - E15B - E20B Paper: D10B Wire mesh: B60B <b>For 210 bar differential collapse pressure:</b> Inorganic microfiber: F01B - F03B - F05B - F10B - F15B - F20B Wire mesh: W60B
<b>TEMPERATURE RANGE:</b>	with NBR seal from -30 °C to +100 °C  with FKM seal (OPTION) from -25 °C to +120 °C
<b>FLUID COMPATIBILITY:</b>	Full with HH-HL-HM-HV HETG-HEES (acc. to ISO 6743/4). For use with other fluid please contact Filtrec Customer Service (info@filtrec.it).

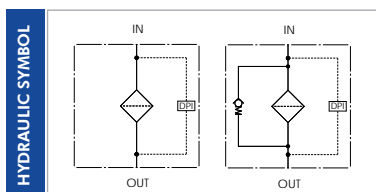

## OVERALL DIMENSIONS

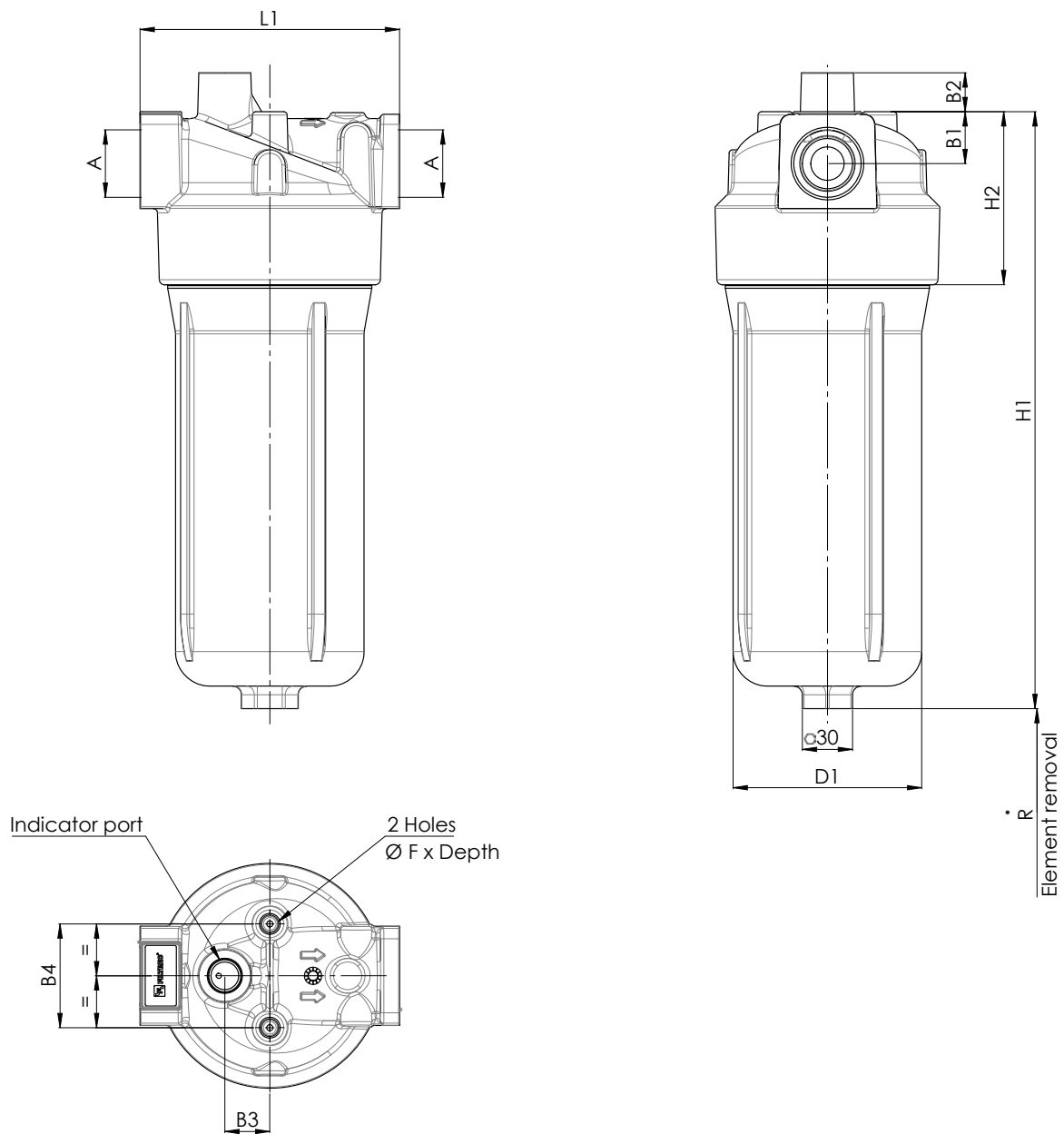

## NOMINAL SIZE

MODEL	A	B1	B2	B3	B4	D1	F	H1	H2	L1	R	WEIGHT
F040-DMD0005								160				1,0 Kg
F040-DMD0008	G 3/4"	19	28	15	45	65	M8x12	238	100	95	110	1,3 Kg
F040-DMD0011								312				1,6 Kg
F040-DMD0015	G 1 1/4"	30	24	26	60	109	M12x18	230	100	150	130	2,9 Kg

## OVERALL DIMENSIONS

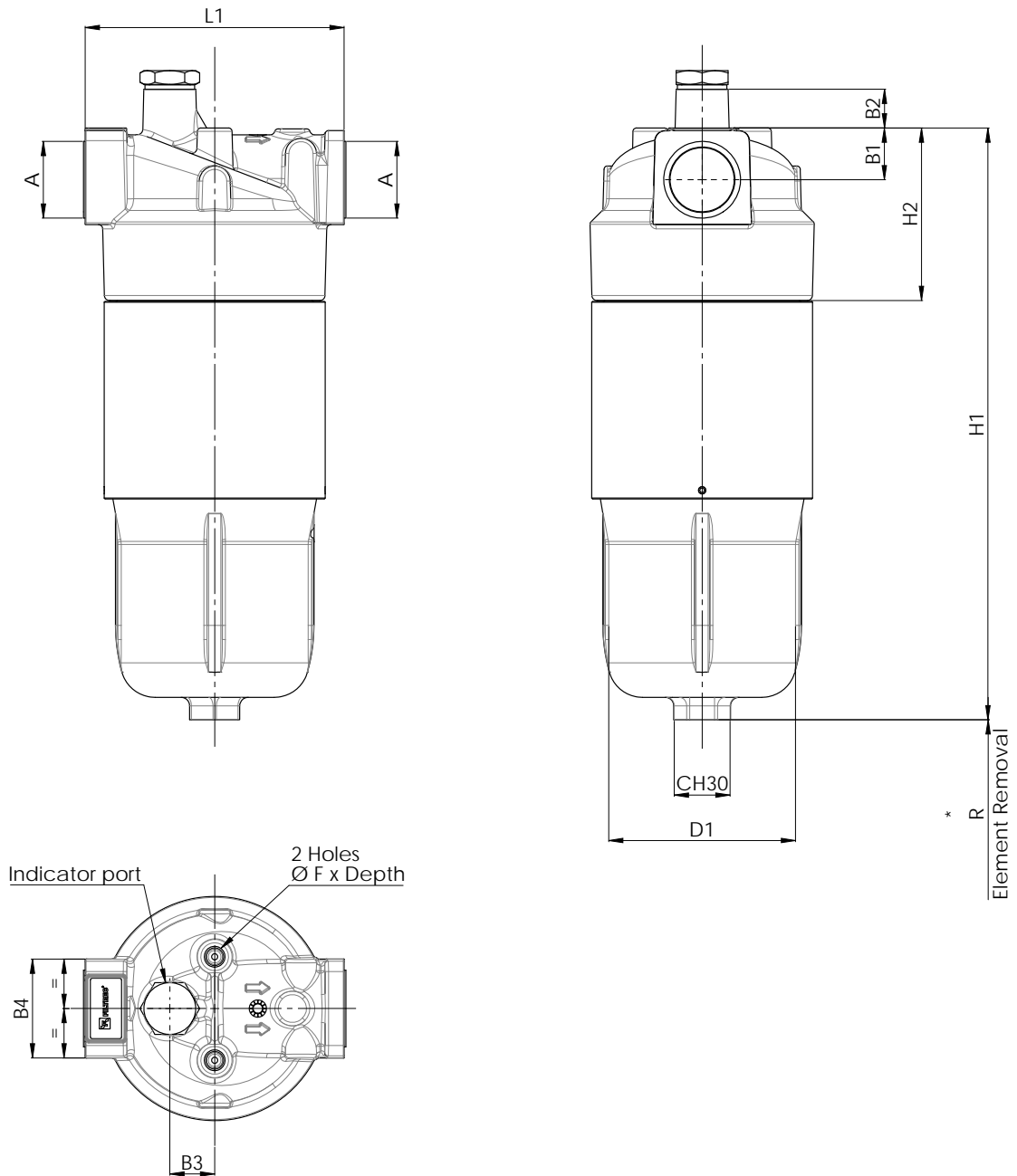

## NOMINAL SIZE

MODEL	A	B1	B2	B3	B4	D1	F	H1	H2	L1	R	WEIGHT
F040-DMD0030	G 1 1/4"	30	24	26	60	109	M12x18	343	100	150	130	3,9 Kg
F040-DMD0045								461				

## ORDERING INFORMATION

	1.	2.	3.	4.	5.	6.	7.	8.	9.	10.	11.
	<b>F040</b>	<b>DMD</b>	<b>0015</b>	<b>E10B</b>	<b>B</b>	<b>B4</b>	<b>D</b>	<b>W</b>	<b>000</b>	<b>S</b>	<b>0</b>
SPARE ELEMENT		<b>DMD</b>	<b>0015</b>	<b>E10B</b>							

1. FILTER SERIES	F040		
2. FILTER ELEMENT SERIES	DMD		
3. FILTER SIZE	0005-0008-0011		
	0015-0030-0045		
4. FILTER MEDIA	000	no element	
For different media options please check availability with Filtrec Customer Service.	E01B	glassfiber $\beta_{4\mu\text{m(c)}} \geq 1.000$	
	E03B	glassfiber $\beta_{5\mu\text{m(c)}} \geq 1.000$	
	E05B	glassfiber $\beta_{7\mu\text{m(c)}} \geq 1.000$	
	E10B	glassfiber $\beta_{12\mu\text{m(c)}} \geq 1.000$	30 bar collapse pressure
	E15B	glassfiber $\beta_{17\mu\text{m(c)}} \geq 1.000$	
	E20B	glassfiber $\beta_{22\mu\text{m(c)}} \geq 1.000$	
	D10B	cellulose $\beta_{10\mu\text{m(c)}} \geq 2$	
	B60B	wire mesh $60\mu\text{m}$	
	F01B	glassfiber $\beta_{4\mu\text{m(c)}} \geq 1.000$	
	F03B	glassfiber $\beta_{5\mu\text{m(c)}} \geq 1.000$	
	F05B	glassfiber $\beta_{7\mu\text{m(c)}} \geq 1.000$	
	F10B	glassfiber $\beta_{12\mu\text{m(c)}} \geq 1.000$	210 bar collapse pressure
	F15B	glassfiber $\beta_{17\mu\text{m(c)}} \geq 1.000$	
F20B	glassfiber $\beta_{22\mu\text{m(c)}} \geq 1.000$		
	W60B	wire mesh $60\mu\text{m}$	
5. SEALS	B	NBR	
*complete filter seals	V	FKM (on request)	
6. CONNECTIONS	B4	G 3/4" for size 0005-0008-0011	
	B6	G 1 1/4" for size 0015-0030-0045	
7. BYPASS VALVE	0	no by-pass	
	D	3,5 bar	
8. INDICATOR PORT OPTION	S	with metal plug	
	W	with plastic plug	
9. COMPULSORY FIELD	000	Filtrec standard	
10. CORROSION PROTECTION	S	standard	
11. OPTIONS	0	standard	

## ACCESSORIES

The accessories must be ordered separately

### INDICATOR

(Y and F) digit for FKM seal option  
For other options see clogging indicators catalogue

V02 (VY2)	differential visual 2,7 bar	
E02 (EF2)	differential electrical 2,7 bar	
E02L (EF2L)	differential electric 2,7 bar + *LC24	
VEF2	differential visual and electric 2,7 bar	
V05 (VY5)	differential visual 5 bar	
E05 (EF5)	differential electrical 5 bar	recommended for no by-pass option
E05L (EF5L)	differential electric 5 bar + *LC24	
VEF5	differential visual and electric 5 bar	
LC24	LED connector	

## PRESSURE DROP ( $\Delta p$ ) INFORMATION FOR FILTER SIZING

The total Delta P through a filter assembly is given from Housing  $\Delta p$  + Element  $\Delta p$ .

This ideally should not exceed 1,0 bar and should never exceed 1/3 of the set value of the by-pass valve. N.B. All the reported data have been obtained at our laboratory, according to specification ISO3968 with mineral oil having 32 cSt viscosity and density 0,875 Kg/dm<sup>3</sup>.

### HOUSING PRESSURE DROP

The housing  $\Delta p$  is given by the curve of the considered model and port, in correspondence of the flow rate value.

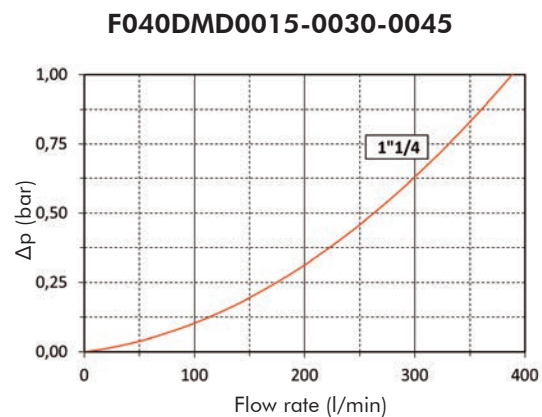
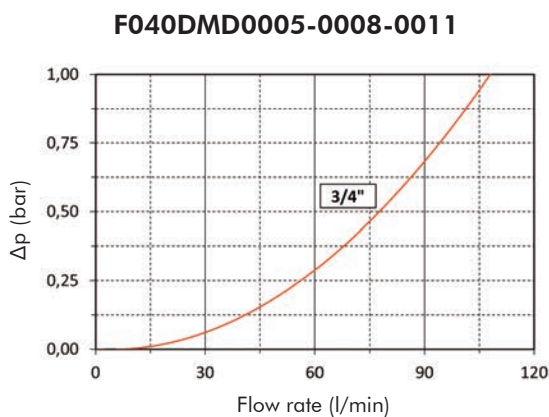

### ELEMENT PRESSURE DROP (filter element 30 bar collapse)

The element  $\Delta p$  (bar) is given by the flow rate (l/min) multiplied by the factor in the table here below corresponding to the selected media and divided by 1000.

If the oil has a viscosity  $V_x$  different than 32 cSt a corrective factor  $V_x/32$  must be applied.

Example: 60 l/min with DMD0011E10B and oil viscosity:  $(60 \times 5,10)/1000 \times (46/32) = 0,44$  bar

	<b>E01B</b>	<b>E03B</b>	<b>E05B</b>	<b>E10B</b>	<b>E15B</b>	<b>E20B</b>	<b>D10B</b>	<b>B60B</b>
<b>DMD0005</b>	49,98	34,99	29,14	17,71	12,16	10,67	8,84	3,54
<b>DMD0008</b>	30,99	21,69	12,56	9,00	5,92	4,99	3,56	1,42
<b>DMD0011</b>	22,17	15,52	9,30	5,10	3,75	3,15	2,58	1,03
<b>DMD0015</b>	10,55	7,39	4,25	2,40	1,68	1,20	1,04	0,42
<b>DMD0030</b>	5,62	3,93	2,57	1,18	0,93	0,72	0,63	0,25
<b>DMD0045</b>	3,48	2,43	1,53	0,99	0,68	0,50	0,48	0,17

### EXAMPLE OF TOTAL $\Delta p$ CALCULATION

F040DMD0011E10BBB4DW000S0 with 60 l/min and oil 46 cSt:

Housing  $\Delta p$  0,27 bar + element  $\Delta p$  0,44 bar  $(60 \times 5,10/1000 \times 46/32) =$  total assembly  $\Delta p$  0,71 bar

## ELEMENT PRESSURE DROP (filter element 210 bar collapse)

The element  $\Delta p$  (bar) is given by the flow rate (l/min) multiplied by the factor in the table here below corresponding to the selected media and divided by 1000.

If the oil has a viscosity  $V_x$  different than 32 cSt a corrective factor  $V_x/32$  must be applied.

Example: 60 l/min with DMD0011F10B and oil viscosity 46 cSt:  $(60 \times 6,63)/1000 \times (46/32) = 0,57$  bar

	F01B	F03B	F05B	F10B	F15B	F20B	W60B
DMD0005	64,37	45,23	37,88	23,41	15,81	13,84	4,43
DMD0008	40,29	28,34	16,33	11,39	7,7	6,63	1,72
DMD0011	28,82	20,18	12,09	6,63	4,88	4,36	1,22
DMD0015	13,72	9,8	5,53	3,12	2,18	1,56	0,54
DMD0030	7,35	5,23	3,34	1,54	1,21	0,94	0,32
DMD0045	4,52	3,16	1,99	1,39	0,88	0,65	0,22

## EXAMPLE OF TOTAL $\Delta p$ CALCULATION

F040DMD0011F10BBB4DW000S0 with 60 l/min and oil 46 cSt:

Housing  $\Delta p$  0,27 bar + element  $\Delta p$  0,57 bar  $(60 \times 6,63)/1000 \times (46/32) =$  total assembly  $\Delta p$  0,84 bar

## BYPASS VALVE PRESSURE DROP

The bypass valve  $\Delta p$  is given by the curve of the considered model and setting, in correspondence of the flow rate value.

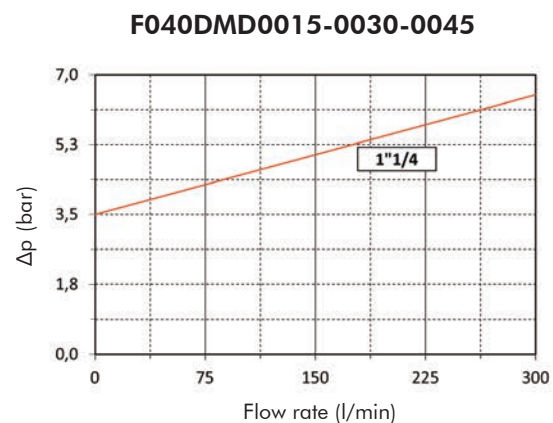
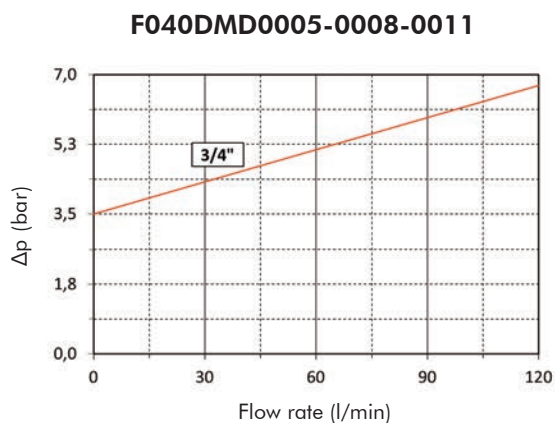

N.B. All the reported data have been obtained at our laboratory, according to specification ISO3968 with mineral oil having 32 cSt viscosity and density 0,875 Kg/dm<sup>3</sup>.

## USER TIPS



- 1 FILTER HEAD
- 2 INDICATOR PLUG
- 3 FIXING HOLES
- 4 FILTER ELEMENT
- 5 FILTER BOWL
- 6 SEAL KIT
- 7 IDENTIFICATION LABEL

### INDICATOR TIGHTENING TORQUE

50 Nm

### SPARE SEAL KIT PART NUMBER (6)

	NBR	FKM
F040 DMD005/8/11	06.021.00127	06.021.00128
F040 DMD0015/30/45	06.021.00129	06.021.00130

### BOWL TIGHTENING TORQUE

screw up filter fill end



## WARNING

-  Make sure that Personal Protective Equipment (PPE) is worn during installation and maintenance operation.

## DISPOSAL OF FILTER ELEMENT

-  The used filter elements and the filter parts dirty of oil are classified as "Dangerous waste material": they must be disposed according to the local laws by authorized Companies.



## INSTALLATION

-  1. The IN and OUT ports must be connected to the hoses in the correct flow direction, an arrow shows on the filter head (1).
- 2. The filter housing should be preferably mounted with the bowl (5) downward.
- 3. Secure to the frame the filter head (1) using the threaded fixing holes (3).
- 4. Verify that no tension is present on the filter after mounting.
- 5. Enough space must be available for filter element replacement.
- 6. The visual clogging indicator must be in an easily viewable position.
- 7. When an electrical indicator is used, make sure that it is properly wired.
-  8. Never run the system with no filter element fitted.
- 9. Keep in stock a spare FILTREC filter element for timely replacement when required.

## OPERATION

-  1. The filter must work within the operating conditions of pressure, temperature and compatibility given in the first page of this data sheet.
- 2. The filter element must be replaced as soon as the clogging indicator signals at working temperature (in cold start conditions, oil temperature lower than 30°C, a false alarm can be given due to oil viscosity).
- 3. If no clogging indicator is mounted, replace the element according to the system manufacturer's recommendations.

## MAINTENANCE

-  1. Make sure that the system is switched off and there is no residual pressure in the filter.
- 2. Unscrew the bowl (5) by turning it anti-clockwise and remove it.
- 3. Remove the dirty element (4).
- 4. Fit a new FILTREC element (4), verifying the part number, particularly concerning the micron rating; open its plastic protection on the open end side and insert it onto the spigot in the filter head, then remove completely the plastic protection.
- 5. Clean carefully the bowl; check the O-rings (6) conditions and replace if necessary.
- 6. Lubricate the bowl's thread (5) and screw it by hand in the filter head (1) by turning it clockwise.
- 7. Screw in the bowl to stop.
-  8. The used filter elements cannot be cleaned and re-used.

